

20²²
23



1852 | MAR
INE
QUALITY

1852 MARINE QUALITY

The inspiration for the brand comes from the maritime environment.

A nautical mile is a unit of measurement of distance used at sea, in the air and in meteorology.

An international nautical mile is exactly 1852 meters.

1852 MARINE QUALITY

If you sail for one hour at a speed of one knot, you have sailed one nautical mile.

1852 is our own private label brand and a guarantee for quality products at the right price "value for money".
Produced especially for Palby Marine in Denmark, Nautec in Sweden and Flak in Norway.

We have over 1000 products from 1852 in our range.

The products range widely - from wetsuits to polishing machines, rubber boots, binoculars, oil, melamine tableware, water sports etc.

1852 CR50 COMPRESSOR REFRIGERATOR

Compressor refrigerator, 12/24V DC - 5/2.5 Amp - 60W

- Noise level: <45dB
- Right- or left-handed door
- With LG compressor
- Remove freezer for larger cold room
- Storage volume: approx. 48 litres, including 9.5 liter freezer compartment
- Weight: 17 kg
- Dimensions (W x H x D): 380 x 534 x 500 mm

Refrigerator frame for CR50
1283259



1852 CR65 COMPRESSOR REFRIGERATOR

Compressor refrigerator, 12/24V DC - 5/2.5 Amp - 60W

- Noise level: <45dB
- Right- or left-handed door
- With LG compressor
- Remove freezer for larger cold room
- Storage volume: approx. 65 litres, including 18 liter freezer compartment
- Weight: 19 kg
- Dimensions (W x H x D): 470 x 630 x 431 mm

Refrigerator frame for CR65
1283262



Refrigerator door panel optional

Stainless steel 1283261-1

Grey 1283261-2

Wood look 1283261-3



1852 COMPRESSOR ICE CUBE MACHINE ICE16

Never go down on ice cubes for your drinks!
 Fill the tank with water and select on the LED panel which size ice cube you want.
 In just 7 minutes, the machine produces your ice cubes.

- 700 g ice cube tray
- The ice machine has a handle so it is easy to move around.
- 12V/24V/240V
- 1.2 / 0.5 Amp
- Noise level: <45dB
- Dimensions (L x W x H): 355 x 238 x 351 mm
- Weight 9.2 kg
- Universal power supply for cigar plugs with 2.5 meter cable

1283265



Easy emptying



With handle - easy to move



700 g ice cube bucket & ice scoop



Makes oblong ice cubes

ICEMASTER® PRO COOLER/ICE BOXES

The IceMaster® Pro combines performance, strength and durability and can keep ice frozen for more than 6 days.

- Ice cream can be kept frozen for more than 6 days (tested at 25°C)
- 50 mm thick CFC-free PU foam insulation
- Food-approved silicone rubber ring in lid
- FDA food approved PP inside
- 2-way attachment points for safe transport
- Black stainless steel brackets/locks
- Double drain for emptying (fast/slow)
- Heavy duty handle & bottle opener
- Tape measure punched on the lid



2-way attachment points for safe transport



Black stainless steel fittings/locks



Heavy duty handle & bottle opener



Double drain for emptying (fast/slow)



Tape measure punched on the lid



Food-approved silicone rubber ring in lid

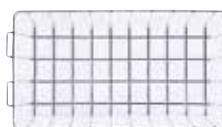

Accessories: basket, freezer element & cutting board/room
 For Pro 50 **1283296**
 For Pro 70 **1283298**
 For Pro 120 **1283299**



IceMaster Pro 50 liters
 External size: L: 70,7 x B: 37,2 x H: 38,0 cm
 Internal size: L: 60,0 x B: 29,5 x H: 26,9 cm
1283292



IceMaster Pro 70 liters
 External size: L: 75,6 x B: 42,3 x H: 44,4 cm
 Internal size: L: 64,9 x B: 33,0 x H: 31,6 cm
1283293



IceMaster Pro 120 liters
 External size: L: 90,0 x B: 50,0 x H: 52,5 cm
 Internal size: L: 77,8 x B: 39,5 x H: 37,8 cm
1283294

1852 COMPRESSOR COOLER BOX 55 LITRES

1852 compressor cooler box is perfect for the boat, the car, the caravan
The refrigerator with double zone

- LCD display/ control panel
- USB outlet for mobile phone charging, lamps, tablets, etc.
- 3-step battery protection
- Both for 12/24 Vdc or 110-240 Volt
- Compressor cooling or freezing down to -20°C
- With LG compressor
- Universal power supply for cigar plugs with 2.5 meter cable

55 liters w/LED light, which lights up when the lid is opened
Equipped with strong carrying handles and a display that shows the temperature.

Lid can be opened to both sides

Digital panel that allows you to simple and economical control of the cooling box. Can be controlled via app.

2-part Cool/freeze or Cool/cool - Freeze/freeze

Weight 17 kg

Size 647 x 400 x 571 mm (+ 25 mm on each side)

Consumption 5 (12V)/2.5 (24V) Amp - 0.25 Kw.h/24T

Average power consumption: 60W

1283254



Highly efficient cooling
range from +10°C to -20°C



1852 COMPRESSOR COOLER BOX 95 LITRES

1852 compressor cooler box is perfect for the boat, car, caravan etc.
The cooling box is a 2-part fridge/freezer

- LCD display/ control panel
- USB outlet for mobile phone charging, lamps, tablets, etc.
- 3-step battery protection
- Both for 12/24 Vdc or 110-240 Volt
- Compressor cooling or freezing down to -20°C
- With LG compressor
- Universal power supply for cigar plugs with 2.5 meter cable

95 liters w/LED light, which turns on when the lid is opened
Equipped with strong carrying handles and a display that shows the temperature.

Lid can be opened to both sides

Digital panel that allows you to simple and economical management of the cold box.

Can be controlled via app.

2-part Cool/freeze or Cool/cool - Freeze/freeze

Weight 24 kg

Size 826 x 528 x 465 mm (+ 25 mm on each side)

Consumption 6 (12V)/3 (24V) Amp - 0.3 Kw.h/24T

1283255



Control cooler box via
The Alpicool app



Highly efficient cooling
range from +10°C to -20°C



Light when lid is opened



Bottom plug



Digital panel / Handle plug

1852 COMPRESSOR COOLER BOX 30, 50 LITRES

1852 compressor coolers are perfect for trips in the boat, car, caravan etc. Both models have two wheels and an adjustable handle.

- LCD display/ control panel
- USB outlet for mobile phone charging, lamps, tablets, etc.
- 3-step battery protection
- Both for 12/24 Vdc or 110-240 Volt
- Compressor cooling or freezing down to -20°C
- With LG compressor 
- Universal power supply for cigar plugs with 2.5 meter cable

Control cooler box via The Alpicool app



30 liters

Weight 11.6 kg
Consumption 3.75/1.875 Amp - 0.2 Kw.h/24H
Size 631 x 375 x 378 mm
1283251

40 liter

Weight 12.9 kg
Consumption: 3.75/1.875 Amp - 0.2 Kw.h/24T
Size 631 x 480 x 378 mm
1283252

50 liters

Weight 13.4 kg
Consumption 3.75/1.875 Amp - 0.2 Kw.h/24H
Size 631 x 550 x 378 mm
1283253

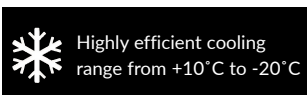
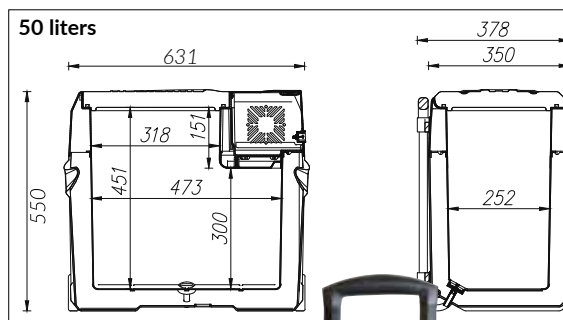
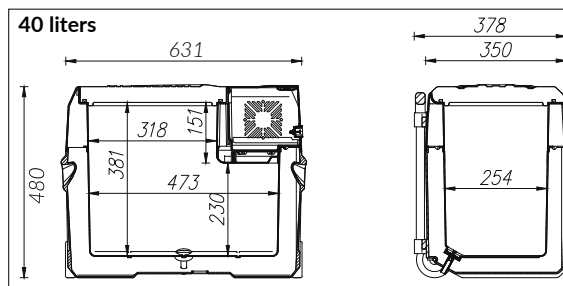
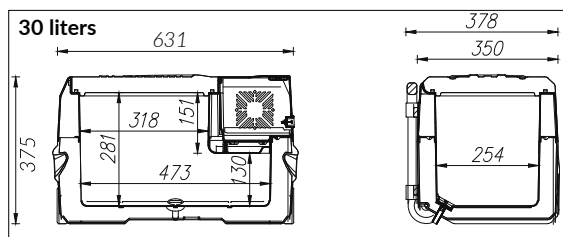

Digital panel



Side handle and wheels



Power supply

1852 BATTERY

Extra battery for 1852 coolers
1283256





Centerfocus

Optical quality
BAK-4 = excellent quality

Multi Coated Lens

Eyepiece
Fold-down
eye cups

Non-slip grip

1852 MATE 7X50

- BK-7 Prism
- Rubber reinforced
- Foldable eye pieces - great advantage for those who wears glasses
- Viewing angle: 7.1 (119 m V/1000 m)
- Water repellent

Auto focus 1113750



1852 WATERSPORT 7X50

- BK-4 Prism
- Black/blue rubber reinforcement
- Foldable eye pieces - great advantage for those who wears glasses
- Fully multi coated lenses
- Viewing angle: 6.6 (115m/1000m)
- Waterproof
- 19.8 x 6.5 x 20.2 cm - 989 g

Center focus 1113755



1852 CREW 7X50

- BK9 Prism
- Black/blue rubber reinforcement
- Foldable eye pieces - great advantage for those who wears glasses
- Fully coated lenses
- Viewing angle: 6.6 (115m/1000m)

Auto focus 1113753



1852 OUTDOOR 8X42

- BK-4 Prism
- Black rubber reinforcement
- Pop up eye cups
- Viewing angle: 6.6 (116m v/1000m)
- Nitrogen gas filled
- Multi Coated
- Waterproof 1.5M/30min
- 14 x 5 x 12 cm

Center focus 1113748



1852 MARINE
OUTRY **1. MATE 7X50**

- BK-4 Prism
- Shock-absorbing black/blue rubber reinforcement
- Foldable eye pieces - great advantage for those who wears glasses
- Viewing angle: 7.5 (132m v/1000m)
- Nitrogen gas filled
- Full multi coated
- Waterproof
- Floating
- 20 x 8 x 15cm - 885 g

Individual focus
1113756



1852 MARINE
OUTRY **CAPTAIN 7X50**

- BK-4 Prism
- Shock-absorbing black/blue rubber reinforcement
- Foldable eye pieces - great advantage for those who wears glasses
- Viewing angle: 7.5 (132m v/1000m)
- Nitrogen gas filled
- Full multi coated
- Waterproof
- Floating
- With compass
- 20 x 8 x 15 cm - 885 g

Individual focus
1113757



1852 MARINE
OUTRY **COMMANDER 7X50**

- BK-4 Prism
- Rubber reinforced
- Foldable eye pieces - great advantage for those who wears glasses
- Fully coated lenses
- Viewing angle: 6.6 (115 m v/1000 m)
- Nitrogen gas filled
- Waterproof
- Bearing compass with scale and light
- 19.8 x 6.5 x 20.2 cm - 989 g
- With floatable strap and bag

Auto focus 1113758



All binoculars are supplied with/bag and strap

1852 MARINE
OUTRY **ADMIRAL 7X50**

- BK-4 Prism
- Shock-absorbing blue rubber reinforcement
- Viewing angle: 7 (132m v/1000m)
- Eye lenses 23 mm
- Foldable eye pieces - great advantage for those who wears glasses
- Nitrogen gas filled
- Full multi coated lenses
- Waterproof & fog-free
- Digital compass, barometer, thermometer & altimeter
- Distance meter/calculator
- 20 x 8 x 15 cm - 1058 g

Individual focus
1113759



Distance meter/calculator

1852 MARINE
OUTRY **BRACKET MOUNTED COMPASS WITH LIGHT**

- Ø 70 mm
- White or black
- 12V light
- Bulkhead or flush mounted

Black with bracket
1111714

White with bracket
1111715



1852 MARINE
OUTRY **VHF ANTENNAS**



VHF sailboat antenna with stainless steel whip, 99 cm, 6 dBi, bracket and SO239 connector
1114001

VHF motor boat antenna with fiberglass whip, 105 cm, 7 meter cables, 2 connectors UHF & FME
• LNB frequency range 156/162 MHz
• Gain 3dB
1114005



velex MARINE BLUETOOTH KIT WITH SPEAKER AND CONTROL

A perfect music system for small boats from VELEX.
2 pcs. 6.5" marine speakers included.
Class A/B amplifier with 180W max output.

- Bluetooth
 - 4 channels
 - 4 x 45W 4 Ohm amplifier
 - Control panel IP 67 with light and 10-foot cable
 - Amplifier IP6
 - USB/AUX
 - 1 Amp USB port
- 1114875



velex MARINE RADIO SET DAB+/FM WITH 2 SPEAKERS

A very good quality stereo package from VELEX.
Two 6.5" speakers are included.

- Bluetooth
- DAB+/FM
- 4x45W
- IPX5
- USB/Aux, Motorola and Phono Out
- Ø 89 mm
- FM antenna for external mounting included



NB! DAB+ antenna is not included in the set.
1114876

PROMARINE BLUETOOTH SPEAKER

2-way bluetooth speaker starter kit w/amplifier 6.5"

12V for speakers that can be connected to a phone or other playback device via Bluetooth. There is a master speaker and a slave speaker in the set, and you can connect as many slave speakers as you want, they just have to be within 30 meters of the master unit.

Masters

- 150W
- 20W amplifier in the speakers
- IPX5
- Low magnetism
- UV protected
- Installation depth: 79 mm
- Diameter: 175 mm
- Hole dimensions: 158 mm
- Range to play source max 20 m
- Range between master and slave max 30 m

Black 1114866

White 1114867

Extra slave set 6.5" 150W

For those who want more than 2 speakers

White 1114868

Black 1114869



1852 INVERTERS WITH MODIFIED SINE CURVE

The inverters convert 12 V to 220 V 50 Hz with effects from 150 W to 1000 W. Inverters with a modified sine curve are ideal for connecting TVs, mobile phone chargers, small kitchen appliances, tools, etc. Always pay close attention to the power (W) stated on the appliance you want to connect the inverter to before connecting it.

ATTENTION Many consumables use 3-4 times more power at the start moment!

The inverters with a modified sine curve have **SOFTSTART**, which means that it can withstand the large starting consumption, so you can choose your inverter according to the power that is written on the item of use, and not 3-4 times more powerful.

Modified sine curve: Modified sine curve is an angular current curve, the current we know from our house is a "pure" current.

CE RoHS

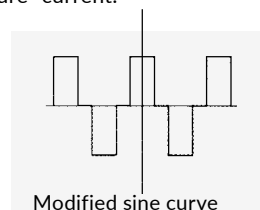

Item no	1250460	1250461	1250462	1250463
AC Output (continuously)	150W	300W	500W	1000W
AC peak load	300W (2 sek)	600W (2 sek)	1000W (3 sek)	2000W (2 sek)
DC input voltage	10,5-15Vdc	10,5-15Vdc	10,5-15Vdc	10,5-15Vdc
Low input indication	10,5V +/- 0,5V	10,5V +/- 0,5V	10,5V +/- 0,5V	10,5V +/- 0,5V
High input indication	16V +/- 0,5V	16V +/- 0,5V	16V +/- 0,5V	16V +/- 0,5V
Congestion shut down	180W	360W	600W	1200W
Protected against short circuit	✓	✓	✓	✓
Fan	✓	✓	✓	✓
USB socket	✓	✓	✓	✓
AC output voltage	230Vac	230Vac	230Vac	230Vac
AC output voltage curve	Modified	Modified	Modified	Modified
Efficiency at full load	85%	85%	85%	85%
Consumption without load	0,21A	0,23A	0,28A	0,37A
Dimensions in mm	120x100x50	120x100x50	150x100x50	210x150x70
Weight	0,55 kg	0,65 kg	0,85 kg	1,9 kg

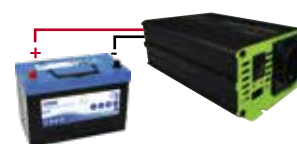

Inverters with a modified sine curve are ideal for connecting:
TV, mobile phone chargers, small kitchen appliances, tools, etc

1852 INVERTERS WITH PURE SINE CURVE

The inverters convert 12 V to 220 V 50 Hz with effects of 400 W and 1000 W. Pure sine wave inverters can be used for all electrical equipment. Always pay close attention to the power (W) stated on the appliance you want to connect the inverter to before connecting it.

ATTENTION Many consumables use 3-4 times more power at the start moment!

The inverters with a modified sine curve have **SOFTSTART**, which means that it can withstand the large starting consumption, so you can choose your inverter according to the power that is written on the item of use, and not 3-4 times more powerful.

PURE sine curve: is the same current that we have in our houses.

CE RoHS

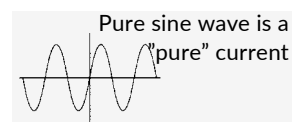

Item no	1250466	1250467	1250468
AC Output (continuously)	400W	1000W	1500W
AC peak load	800W	2000W	3000W
DC input voltage	10,5-15Vdc	10,5-15Vdc	10,5-15Vdc
Low input indication	10,5V +/- 0,5V	10,5V +/- 0,5V	10,5V +/- 0,5V
High input indication	16V +/- 0,5V	16V +/- 0,5V	16V +/- 0,5V
Congestion shut down	480W	1200W	1800W
Protected against short circuit	✓	✓	✓
Fan	✓	✓	✓
USB socket	✓	✓	✓
AC output voltage	230Vac	230Vac	230Vac
AC output voltage curve	Pure	Pure	Pure
Efficiency at full load	90%	90%	90%
Consumption without load	0,40A	0,50A	0,56A
Dimensions in mm	160x150x70	310x150x70	290x220x90
Weight	1,5 kg	3 kg	4,2 kg

1852 remotecontrol for 1852 inverter 1250470



Photo: Per Heegaard

1852 PRO SMART CHARGERS

Universal smart chargers that are very simple to use. Available in 3 models - 4 Amp - 8 Amp - 16/8 Amp.

- With crocodile beak and ring cable lugs
- Charging: Fast, slow and winter mode
- LCD display with light
- Built-in battery tester.
- Short circuit protected
- Charges all batteries - including lithium.

4 Amp

- 6V og 12V

1251000

8 Amp

- 12V
- 9 stage charging
- Desulfation - extends battery life

1251001

16/8 Amp

- 12/24V
- 9 stage charging
- Desulfation - extends battery life

1251002



1251000



1251002



1251001



BATTERY BOX HOLDER

Battery box holder for trailer hitch
Aluminum 1170735
Hot-dip galvanized steel 1170738

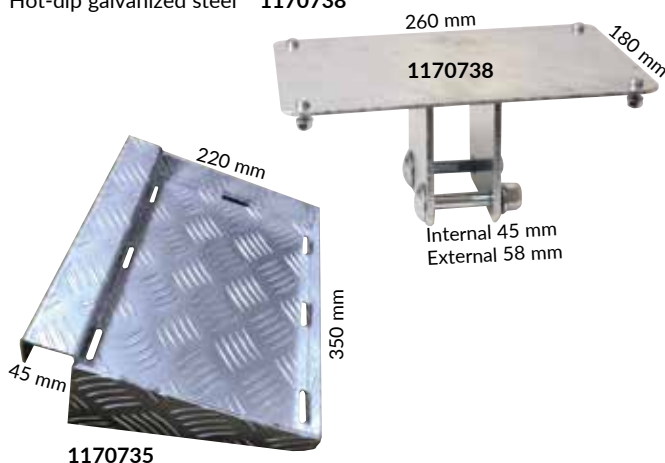

1852 TINNED COPPER CABLE

High temperature thin wall low voltage cables suitable for use in marine and other harsh environments.

The tinned copper conductors make this cable more corrosion resistant.

- Manufactured in accordance with ISO 6722-1: 2011 (Class B).
- Hard PVC insulation saves weight and provides good resistance to wear and can be cut through.
- Good resistance to petrol, diesel oil, lubricating oils and diluted acid.
- Suitable for 12V and 24V systems (max. 60V).
- Insulated copper conductors, PVC insulated.
- Suitable for use at temperatures from -40°C to 105°C.
- Very good resistance to moisture.
- The cables are printed with the specification on the insulation.

SINGLE INSULATED TINNED MOUNTING CABLE:

Colour	Cross section	Outside mm	Roll lgt	Item no
Red	1,5 mm ²	Dia 2,4	10 meter	1253121
Black	1,5 mm ²	Dia 2,4	10 meter	1253125
Red	2,5 mm ²	Dia 3,0	10 meter	1253131
Black	2,5 mm ²	Dia 3,0	10 meter	1253135
Red	4,0 mm ²	Dia 3,7	10 meter	1253139
Black	4,0 mm ²	Dia 3,7	10 meter	1253143
Red	6,0 mm ²	Dia 4,3	10 meter	1253147
Black	6,0 mm ²	Dia 4,3	10 meter	1253151
Red	10,0 mm ²	Dia 6,0	5 meter	1253155
Black	10,0 mm ²	Dia 6,0	5 meter	1253159



SINGLE INSULATED EXTRA FLEXIBLE BATTERY/WELDING CABLES DESIGNED FOR USE IN HARSH WORKING ENVIRONMENTS.

Colour	Cross section	Outside mm	Roll lgt	Item no
Red	16 mm ²	Dia 8,3	10 meter	1253175
Black	16 mm ²	Dia 8,3	10 meter	1253179



2-CONDUCTOR ROUND TINNED COPPER CABLE:

Colour	Cross section	Outside mm	Roll lgt	Item no
Red/black	2 x 1,5 mm ²	Dia 6,4	10 meter	1253163
Red/black	2 x 2,5 mm ²	Dia 6,7	10 meter	1253165



BEST CHOICE



Small packaging from 5 to 10 meters

1852 SEARCHLIGHT T-TRON LED 48W WITH REMOTE CONTROL

The latest generation of remote searchlight. The latest LED technology from Osram; 16 diodes of 3W, a total of 48 Watts. The housing is in aluminum and the grille is magnesium coated to make it extra robust.

- 10-30V (can be used on 12V and 24V systems)
- 48W
- 4320 lumens
- Lux/10m 1600lx
- Light cone: Spot 10° / Flood 90°
- Range Spot 750 m / Flood 150 m
- Lateral rotation: 360°
- Rotation up/down: 180°
- Dim. max: H 244 x W 235 x D 200 mm
- Remote control with a range of 35 m
- Remote control comes without battery
- IP65

1240090

**1852** SEARCHLIGHT LED WITH WIRELESS REMOTE CONTROL 50 WATT

LED searchlight with ABS housing

- IP67
- 50W
- 3500 lumens
- Light cone: 30°
- 10-30V (can be used on 12V and 24V systems)
- Working temperature: -10 - 50°C
- 6500K - white

1240063



STORM LANTERN

Original classic Dietz storm lantern for kerosene/lamp oil.

Width: 13 mm - Height: 250 mm

Content: 210 ml - 14 hours

Fill to a maximum of 3/4 part, as the lamp expands when it is hot.

- | | |
|----------------|---------|
| Black | 1820002 |
| Copper colored | 1820004 |
| Brass colored | 1820005 |
| Red | 1820006 |
| Wick 140 mm | 1820007 |
| Extra glass | 1820008 |



TOTRON LED DECK LIGHT

Top quality deck light with heated lens which prevents icing in cold weather. Indirect light gives higher lumen output per watt. The deck light also has a temperature control system which provides maximum light without damaging the LED lights. Aluminum housing and fittings. Combo light: spot 8° and flood 90°. IP67 - 10-30V. 5700K

Side mounting kit for Totron LED deck lights if you want side mounting
1240094

LED Chip: OSRAM



- WxHxD 206 x 78 x 58 mm
 - 36W • 12x3W
 - 3240 lumens
- 1240095

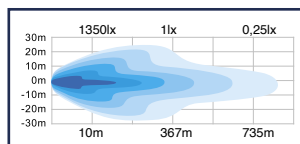

- WxHxD 359 x 78 x 58 mm
 - 72W • 24x3W
 - 6480 lumens
- 1240096

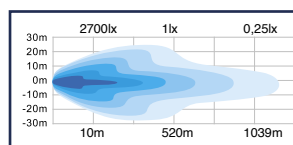

- WxHxD 563x78x58 mm
 - 120W • 40x3W
 - 10800 lumens
- 1240097

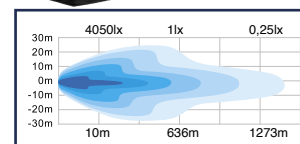

- WxHxD 800x78x58 mm
 - 180W • 60x3W
 - 16200 lumens
- 1240098

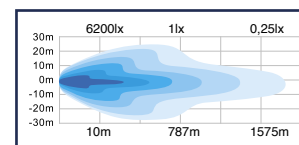

Side bracket set can be purchased additionally. Provides a more flexible installation

UV coated reflector and polycarbonate lens with high durability

Innovative optics design. Reflector with cover to provide indirect light

Protected reflector and LED are machined with high precision, improving the LUX value by more than 50%

Indirect light system prevents glare

Heated lens, which prevents icing in cold weather.

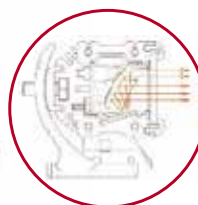

1852 FOR DIVER UTILITY SPOTS

1852 spot models are of high quality, intended for the maritime environment with different brightnesses and in a very robust IP67 waterproof housing made of ABS and thermoplastic rubber, which makes them resistant to shocks and vibrations and with a drop test of 1 meter.

- IP 67 waterproof
- Drop test: 1 meter
- Non-slip handle

- Brightness Lumen 300 - 370M/237M
 - 1 piece. Cree XPGB R5 super bright 3W LED
 - Uses 3 pcs. C/LR14 batteries (not included)
 - Usage: 21 hours/29 hours
 - Trigger switch: high/low/off brightness
 - Diameter 8 cm, weight 900 g
- 1240371**

- Brightness Lumen 500 - 400M/280M
 - 1 piece. Cree XMLB-T6 super bright 5W LED
 - Including 1 pc. rechargeable Lithium 18650 battery (3.7V 3000mAH)
 - Including 100-240V charger and 12 Vdc charger with cigarette plug.
 - Charging time 6-8 hours.
 - Use: 9 hours/20 hours/SOS 24 HOURS
 - Trigger switch: high/low/SOS/off brightness
 - Diameter 9 cm, weight 900 g
- 1240372**



LED SPOTS

A smart LED Spot/diving light with a robust housing that floats, is waterproof. Recharged via the supplied USB plug which can be smartly stored behind the end cover.

- 3 light settings: 100%, 50% or SOS
- IP67 - floating
- Adjustable stand on top of the housing for hands-free lighting
- The housing is made of ABS and polycarbonate

- 10W XPL 500 lumens
 Battery: 18650 lithium (2200MA)
 Charging: 3 hours
 Usage time: 2.5 hours
 Size: 15.5 x 8 x 18 cm - 354 grams
- 1240374**

- 18W XHP 50 1300 lumens
 Battery: 18650 lithium (4400MA)
 Charging: 4-5 hours
 Usage time: 4.5 hours
 Size: 17 x 9 x 18.5 cm - 600 grams
 5V input & output
- 1240375**

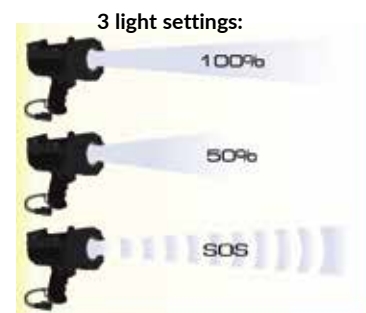

1852 FOR DIVER UTILITY WATERPROOF LED FLASHLIGHT

Compact flashlight with impressive lumen strength, light distance and operating time. CREE high-intensity LED and polycarbonate lens resist vibrations, even drops up to 3 meters without damage. Strong housing made of reinforced nylon fiber with a soft surface, so it is comfortable to hold.

- 1 piece. 3W Cree super powerful LED
 - Brightness: 140 lumens - 120 meters
 - Duration of use: 3 hours
 - 3 x AAA batteries (not included)
 - High/low and flashing brightness
 - IP 67 waterproof
 - Wrist strap
 - Size: 13 cm Dia 30/35mm
- 1171045**



1852

MAR
INE
QU
LITY

Stainless steel fitting

We offer a wide range of AISI 316 stainless steel fittings.

1852 HOSE CONNECTOR



Thread	Hose	Item no
3/8"	10 mm	1066610
3/8"	12 mm	1066620
3/8"	15 mm	1066630
1/2"	12 mm	1066650
1/2"	15 mm	1066660
1/2"	20 mm	1066670
3/4"	20 mm	1066690
3/4"	25 mm	1066700
1"	25 mm	1066720
1 1/4"	32 mm	1066740
1 1/4"	38 mm	1066750
1 1/2"	38 mm	1066760
2"	50 mm	1066770

1852 HOSE CONNECTOR MALE/MALE



Thread	Hose	Item no
1/2"	20 mm	1066820
3/4"	25 mm	1066830
1 1/4"	38 mm	1066850

1852 90° ELBOW



Thread	Item no
3/8"	1067010
1/2"	1067020
3/4"	1067030
1"	1067040
1 1/4"	1067050
1 1/2"	1067060
2"	1067070

1852 90° ELBOW MALE/FEMALE



Thread	Item no
3/8"	1066910
1/2"	1066920
3/4"	1066930
1"	1066940
1 1/4"	1066950
1 1/2"	1066960
2"	1066970

1852 45° ELBOW



Thread	Item no
3/8"	1067510
1/2"	1067520
3/4"	1067530
1"	1067540
1 1/4"	1067550
1 1/2"	1067560

1852 T-PIECE SS



Thread	Item no
3/8"	1067410
1/2"	1067420
3/4"	1067430
1"	1067440
1 1/4"	1067450
1 1/2"	1067460

1852 PIPE CONNECTOR



Thread	Item no
3/8"	1067310
1/2"	1067320
3/4"	1067330
1"	1067340
1 1/4"	1067350
1 1/2"	1067360
2"	1067370

1852 NIPPLE SS



Thread	Item no
3/8"	1067110
1/2"	1067120
3/4"	1067130
1"	1067140
1 1/4"	1067150
1 1/2"	1067160
2"	1067170

1852 HEXAGON BUSHING SS



Thread	Item no
3/8" - 1/4"	1067210
1/2" - 3/8"	1067220
3/4" - 1/2"	1067230
1" - 3/4"	1067240
1 1/4" - 1"	1067250
1 1/2" - 1 1/4"	1067260
2" - 1 1/2"	1067270

1852 PLUG SS EXTERNAL THREAD



Thread	Item no
3/8"	1067610
1/2"	1067620
3/4"	1067630
1"	1067640
1 1/4"	1067650
1 1/2"	1067660

1852 THRU-HULLE SS



Lgt.	Thread	Item no
53	3/8"	1066010
59	1/2"	1066020
68	3/4"	1066030
73	1"	1066040
77	1 1/4"	1066050
80	1 1/2"	1066060
95	2"	1066070



Thread	Hose	Item no
3/8"	15 mm	1066080
1/2"	18 mm	1066081
3/4"	24 mm	1066082
1"	30 mm	1066083
1 1/4"	38 mm	1066084

1852 THRU-HULL SS



Lgt.	Thread	Item no
53	3/8"	1066161
60	1/2"	1066162
68	3/4"	1066163
72	1"	1066164
77	1 1/4"	1066165
78	1 1/2"	1066166

1852 THRU-HULL SS



Thread	Hose	Item no
1/2"	19 mm	1066120
3/4"	25 mm	1066130
1"	32 mm	1066140
1 1/4"	38 mm	1066150

1852 DRAIN

Can be used as a cockpit, sink and shower drain.

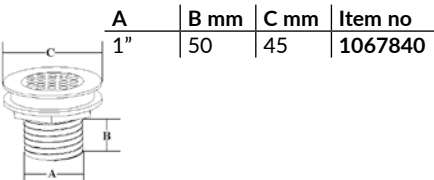

A	B mm	C mm	Item no
1"	50	45	1067840

1852 WATER INTAKE SS



Thread dia - L	Item no
3/8" - 70 mm	1066210
1/2" - 70 mm	1066220
3/4" - 80 mm	1066230
1" - 80 mm	1066240
1 1/4" - 80 mm	1066250
1 1/2" - 80 mm	1066260
2" - 90 mm	1066270

1852 BALL VALVE SS



Thread	Item no
3/8"	1066410
1/2"	1066420
3/4"	1066430
1"	1066440
1 1/4"	1066450
1 1/2"	1066460
2"	1066470

1852 SCUPPER

Cast AISI 316 stainless steel that is highly polished



Thread	Size mm	Item no
1/2" x 65 mm	38x38x18	1066191
3/4" x 65 mm	44x44x20	1066192
1" x 75 mm	50x50x23	1066193
1 1/4" x 79 mm	57x57x27	1066194
1 1/2" x 83 mm	65x65x31	1066195
2" x 90 mm	80x80x44	1066196

1852 INSPECTION COVER SS - AISI 316



Thread	Total dia	Assembly	Item no
3"	114mm	Ø 90mm	1067710
4"	146mm	Ø 12mm	1067720
Key for opening			1067730

1852 FROST GUARD 220V/200W W/THERMOSTAT

The frost guard is suitable for keeping the boat, garage, attic or similar free from frost. Mounted vertically on the wall. Can be used in both dry and damp rooms.

Stepless thermostat +5 to +35° C
L x W x H: 350 x 120 x 75 mm
1102130



1852 DEHUMIDIFIER FOR LOW TEMP., 230V W/5 L TANK

Dehumidifier for boat, caravan, cottage, basement etc. Dehumidifier with absorption technology, i.e. dryer rotor and no compressor therefore perfect for cold and wet rooms. Simple to operate.

- TÜV and CE approved.
 - Tank 5 litres
 - Spout 12mm for direct draining of water
 - 8.5L per day
 - Power consumption: High speed 720W/3.2Amp
Medium speed 710W/3.1Amp
Low speed 380W/1.7Amp
 - Noise level: 39/44/48db
 - Air flow 185 m3/hour
 - Electronic hygrostat with the following levels: 40%/50%/60%/70% RH and continuous
 - Antibacterial filter
 - Operating temperature: 1-32° C
 - Anti-tip protection
 - Hours: 1-24 hours
 - Dimensions: 340 x 221 x 509 mm
 - Weight: 7.5 kg
 - 230V
- 1100000

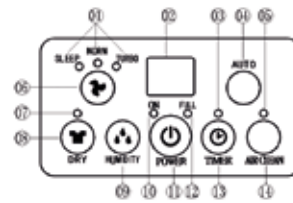

1. FAN SPEED Indicator (Sleep, Norm, Turbo)
2. Humidity/Timer Display Window
3. TIMER Indicator
4. AUTO button
5. AIR CLEAN Indicator
6. FAN SPEED Button
7. DRYER Indicator
8. DRYER Button
9. Humidity Button
10. ON/OFF Indicator
11. Power (ON/OFF) Button
12. "Full Water" indicator
13. TIMER button
14. AIR CLEAN Button



1852 HEATER PIPE 220 VOLT CE

Heating pipes are effective against frost and condensation in the boat. They use extremely little power.

Is perfect to use for winter storage, but also provides a pleasant warmth and is far more energy efficient if used as a normal heat source. The heating pipes are equipped with a safety sensor that automatically switches off the heating pipe if a fault occurs or if the heat exceeds the normal temperature. Supplied with 220V cord and mounting clip.

305 mm 45 watt heating pipe IP 55	1102150
610 mm 80 watt heating pipe IP 55	1102152
915 mm 135 watt heating pipe IP 55	1102154



IMPORTANT
Read the instructions
before installation!

Energy efficient
heat source

1852 CABLE LUGS

1852 tube cable lugs are made of 100 percent heavy tinned copper, which provides very good connection/flow of current resists corrosion from salt and moisture. Seamless barrel design provides maximum strength when crimped. The cable lugs have a closed end, which keeps moisture out, so cables remain dry and corrosion-free.

Cable size	Bolt hole	ØE	ØD	Ød	W	B	L	Thickness	Packing	Item no
6 mm ²	6 mm	6,5 mm	5,5 mm	3,8 mm	11,7 mm	10,0 mm	27,0 mm	1,0 mm	4 pcs	1274040
10 mm ²	8 mm	8,1 mm	7,1 mm	4,8 mm	11,7 mm	13,0 mm	33,3 mm	1,8 mm	4 pcs.	1274044
16 mm ²	8 mm	8,1 mm	8,1 mm	5,8 mm	13,7 mm	15,0 mm	37,1 mm	1,8 mm	4 pcs.	1274047
16 mm ²	10 mm	10,4 mm	8,1 mm	5,8 mm	13,7 mm	15,0 mm	37,1 mm	1,8 mm	4 pcs.	1274048
25 mm ²	8 mm	8,1 mm	9,4 mm	7,1 mm	13,7 mm	15,5 mm	38,9 mm	2,4 mm	4 pcs.	1274050
25 mm ²	10 mm	10,4 mm	9,4 mm	7,1 mm	14,5 mm	15,5 mm	38,9 mm	1,9 mm	4 pcs.	1274051
35 mm ²	8 mm	8,1 mm	11,2 mm	8,4 mm	16,5 mm	16,0 mm	40,9 mm	3,0 mm	4 pcs.	1274053
35 mm ²	10 mm	10,4 mm	11,2 mm	8,4 mm	16,5 mm	16,0 mm	41,1 mm	2,6 mm	4 pcs.	1274054
50 mm ²	8 mm	8,1 mm	13,0 mm	10,4 mm	18,3 mm	19,1 mm	46,7 mm	3,3 mm	4 pcs.	1274056
50 mm ²	10 mm	10,4 mm	13,0 mm	10,4 mm	18,3 mm	19,1 mm	46,7 mm	3,3 mm	4 pcs.	1274057
70 mm ²	8 mm	8,4 mm	14,6 mm	11,3 mm	21,3 mm	24,0 mm	54,0 mm	3,3 mm	2 pcs.	1274058
70 mm ²	10 mm	10,5 mm	14,6 mm	11,3 mm	21,3 mm	24,0 mm	54,0 mm	3,3 mm	2 pcs.	1274059
95 mm ²	10 mm	10,5 mm	17,4 mm	13,5 mm	25,3 mm	27,0 mm	60,0 mm	3,9 mm	2 pcs.	1274061
95 mm ²	12 mm	13,0 mm	17,4 mm	13,5 mm	25,3 mm	27,0 mm	60,0 mm	3,9 mm	2 pcs.	1274062



1852 ELECTRICAL PANEL W/AUTOMATIC FUSE LED

Rocker switches and built-in activation LED diode, red LED light shows switch out of operation and green LED shows it is in operation. Each switch with automatic fuse from 2-15 Amp.

3 switches + 1 on/off switch
(2 x 5, 10 & 15 A)
Str. 100 x 128 mm
Hole size 82 x 107 mm
1270033

5 switches + 1 on/off switch
(3 x 5, 2 x 10 & 15 A)
Str. 100 x 180 mm
Hole size 82 x 160 mm
1270034



1852 ELECTRICAL PANEL WITH AUTOMATIC FUSE

Electrical panel with toggle switches and automatic fuse for 12V-20A/24V-10A. Square illuminated display on which symbols can be applied.

6 switches
(3 x 5, 2 x 10 & 15 A)
Str. 120 x 180 mm
Hole size 90 x 160 mm
1270136

8 switches
(4 x 5, 2 x 10 & 2 x 15 A)
Str. 120 x 235 mm
Hole size 90 x 210 mm
1270137



1852 BATTERY SWITCH

Compact battery changeover 275 Amp. - 12-48 Vdc
Mounts in 52 mm mounting holes
The key can be removed
Simple and economical way to separate two batteries
68 x 68 x 75 mm
1270093



1852 USB OUTLET

Double panel with USB outlet 5V, 1 and 2.1 Amp. and volt/ammeter 0-10 Amp.
1270178

Panel with volt/ammeter
6-30 Vdc - 0-10 Amp.
1270179



1852 USB OUTLET

Double USB outlet 5V 1 and 2.1 Amp.
1270188

Double USB outlet 5V and 2.1 Amp. and cigarette socket 12/24V
1270189



1852 CIRCUIT BREAKER

- IP67
- SAE J1625, SAE J1171 (Sparkproof) C€
- Works in temperatures from -30 to +80°C
- Terminals: M6
- Simple reset function

25 Amp. **1271170**
30 Amp. **1271171**
40 Amp. **1271172**
50 Amp. **1271173**
60 Amp. **1271174**
70 Amp. **1271175**
80 Amp. **1271176**
100 Amp. **1271177**
120 Amp. **1271178**
135 Amp. **1271179**
150 Amp. **1271180**



1852 MAIN SWITCH

275 Amp. - 12-48 Vdc
Mounts in 52 mm mounting holes
The key can be removed
3 side plates can be removed for cable installation
68 x 68 x 75 mm
1271082



1852 FENDER COVER

1852 fender cover is made of thick stretch terry, which protects your fender and boat. When the fender rubs against the boat, it can make an annoying creaking sound, which can be avoided by using a fender cover. The fender cover also protects the fender from the sun's UV rays. Available in grey, navy and black
Lace closure at one end
80% acrylic 20% polyester
Can be washed

Fender cover for:	Size	No	Navy	Black	Grey
F1 Polyform 61x15 cm	54x17 cm	2 stk	1151325	1151348	1151355
F2 Polyform 61x22 cm	54x29 cm	2 stk	1151326	1151349	1151356
F02 Polyform 66x20 cm	59x22 cm	2 stk	1151324	1151347	1151339
F3 Polyform 74,5x22 cm	70x29 cm	2 stk	1151327	1151350	1151357
F4 Polyform 104x22 cm	89x32,5 cm	1 stk	1151328	1151351	1151358
F5 Polyform 77,5x29 cm	61x42,5 cm	1 stk	1151329	1151352	1151359
F6 Polyform 109x29 cm	93x42,5 cm	1 stk	1151345	1151353	1151361
F7 Polyform 102x37,5 cm	90x50 cm	1 stk	1151346	1151354	1151362

Fender cover for buoy fenders					
A1 Polyform	Dia 40x37 cm	1 stk	1151275	1151280	1151288
A2 Polyform	Dia 46x49 cm	1 stk	1151276	1151281	1151289
A3 Polyform	Dia 65x56 cm	1 stk	1151277	1151282	1151290



1852 FENDER HOLDER

Fender holder in dia 6 mm 316 stainless steel.
 • Height 34 cm
 • Included holder can be adjusted at any angle
 • Sold in pairs

Internal dia Top/bottom	Fits (Polyform):	Fits (Majoni):	Fits (Danfender):	Item no
140/110 mm	F01 S/M/L, G2	Star 1, Drop 1	5"	1151383 NEW
165/120 mm	F1, G3	Star 2, Drop 2	-	1151380
185/135 mm	G4	-	6"	1151384 NEW
215/160 mm	F02, F2/3/4, G5	Star 3, Drop 3	8", Light	1151381
265/220 mm	-	Star 4	10"	1151382



1852 FENDER HOLDER

Strong and robust fender holders made of AISI 316 stainless steel with a material thickness of dia 8 mm. Available as a straight or angled model and supplied with mounting brackets. All holders are for 2 fenders.

	Fits (Polyform):	Fits (Majoni):	Fits (Danfender):	Straight	Angled left	Angled right
Fender max dia 175 mm L-410 B-175 H-280 mm	F1, G3/4	Star 2, Drop 2	6"	1151393	1151396	1151401
Fender max dia 225 mm L-530 B-225 H-330 mm	F02, F2/3/4, G5	Star 3, Drop 3	8", Light	1151394	1151397	1151402
Fender max dia 315 mm L-655 B-315 H-600 mm	F5/6	Star 5	12"	1151395	1151398	1151403

Mounting bracket set for fender holders
1151405

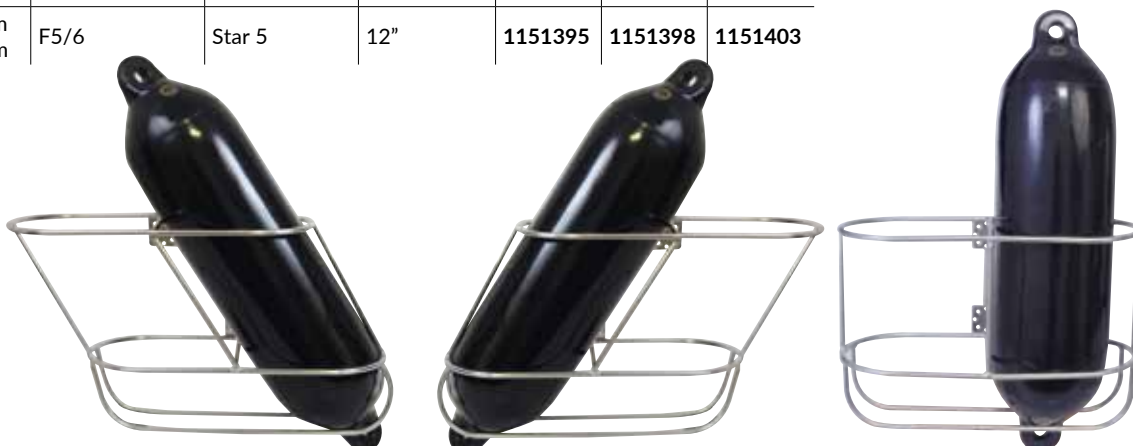

1852 DUAL ACTION ELECTRIC POLISHING MACHINE C€

The ideal polishing machine for the boat, the car etc.

- Oscillating rotation
- 900W
- Adjustable speed 2000 - 6400 revolutions
- Comes with handle, back plate w/velcro and bag
- 2.6 kg
- Ø 150 mm
- C€ approved

Back plate for dual action
8 mm / 5/8" Ø 135 mm
1602135



1852 ELECTRIC POLISHING MACHINE - SMALL AND LIGHT C€

A small and light polishing machine for the perfect polishing job.

Weights only 2 kg and is therefore somewhat more comfortable to perform the polishing work with.

- Stepless speed regulation 0-4300 rpm. Approx. Step 4 is perfect for the polishing task.
- 920W 230V
- Includes Ø 180 mm back plate with velcro
- Standard M14 mm thread
- Supplied with handle
- ONLY 2 kg.
- REMEMBER polishing pads (not included)
- C€ approved



Photo: Jens-Thor Schönemann

1852 POLISHING PADS & ACCESSORIES

Polishing kit: Rubbing and wax pad + microfiber cloth	1760260
Back plate with velcro - Ø 180 mm	1760255
Yellow waffled foam rubbing pad - Ø 200 mm	1760262
Black waffled foam wax roundel - Ø 200 mm	1760265
Soft lambswool polishing pad with velcro - Ø 200 mm	1760268
Lamb's wool polishing pad with velcro - Ø 200 mm	1760269
Microfibre cloth 1st piece 40 x 38 cm	1760273



1760255

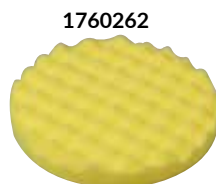

1760262



1760265



1760268



1760269

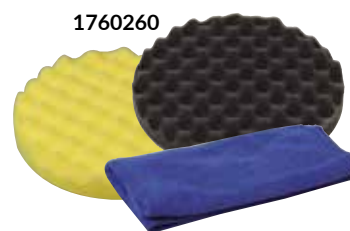

1760260

1852 ALU
FIBRE
WOOD
PP
PVC **WASHING BRUSH WITH WATERFLOW**

Washing brush with extra soft scratch-free bristles.
Solid design with good ergonomic rubber-coated handle.
Good grip, even when the handle is wet.
The rubber edge on the brush head protects the gelcoat from scratches.
Easy thumb control switch - turn water supply on/off.
Standard quick connector.
Material: TPR, PP, PVC brush, ABS.
Brush hair: 8 x 11 cm
Total length: 31 cm
1152462



1852 ALU
FIBRE
WOOD
PP
PVC **WASHING BRUSH W/STIFF BRISTLES & HANDLE**

Washing brush with stiff bristles in fantastic good quality.
Strong and solid handle with anti-slip grip.
With rubber edges for protection.
L: 190 mm • W: 90 mm • H: 95 mm
Brush length: 28 mm
1152610



1852 ALU
FIBRE
WOOD
PP
PVC **BRUSH & SHAFT WITH WATERFLOW**

Hedgehog Brush with/waterflow for shaft 1152600
Soft washing brush w/waterflow & water scraper 1152603
Telescopic shaft w/waterflow & on/off switch 1152601
1.2-1.8 meters
Shaft w/waterflow & on/off switch 1.4 metres 1152602



1152603



1152600



1152601



1152602

Particularly suitable
for freeboard washing

1852 ALU
FIBRE
WOOD
PP
PVC **BOAT BRUSHES & TELESCOPIC BRUSH HANDLE**

- Boat brush for telescopic rod
- Top in white plastic
- Brush head in high quality polyester fibres
- Quick coupling

Telescopic brush handle 100-175 cm 1152542
Telescopic brush handle 150-274 cm 1152543
Hard brush 20 cm (white) 1152547
Medium brush 20 cm (blue) 1152548
Soft brush 20 cm (yellow) 1152549



1852 ALU
FIBRE
WOOD
PP
PVC **BRUSH SET**

- Aluminum telescopic shaft 122 cm
 - A stiff brush
 - A soft brush
 - Boat chin tip that fits on shaft
- 1152520



EVA SHEET FENDER

- Does not absorb liquid
- Easy to stack and store
- Easy to clean
- Robust fender that neither punctures nor loses air
- Foam plastic fender can also be used as a seat pad
- Blue/petrol

Lgt.	Width	Thickness	Item no
50 cm	20 cm	5 cm	1151800
61 cm	30 cm	7,5 cm	1151810
90 cm	30 cm	7,5 cm	1151820



ROCK® ELECTRIC TRAILER WINCH RP2000 CE

IP67 • Free-running function • Incl. relay • Tow hook • Wireless remote control

Model:	RP2000
Boat weight:	app. 600 kg
Drag:	907 kg
Engine:	12V - 1,9HK
Gearing:	153:1
Gear:	Planet gear with automatic stop
Wires:	Dia 4 mm 15 meter
Dim in mm:	285,5 x 113 x 107,5
Weight:	6,5 kg
Item no	1021080



Spare wireless remote control for RP2000 1021087

ROCK® ELECTRIC TRAILER WINCH RP3500 CE

IP67 • Free-running function • Line guide • Incl. relay • Towbar Remote control w/cable

Model:	RP3500 w/rope	RP3500 w/steel
Boat weight:	app. 1050 kg	
Pull:	1589 kg	
Motor:	12V - 3,1HK	
Gearing:	136:1	
Gear:	Planet gear with automatic stop	
Rope:	Ø 5,56 mm 12,8 m	
Dim in mm:	363 x 117 x 120	
Weight:	9,9 kg	11,3 kg
Item no	1021081	1021082

Waterproof control box
for RP3500
1021074

1021081



1021082

ROCK® ELECTRIC TRAILER WINCH RP5000

IP67 • Free-running function • Line guide • Incl. relay • Towbar Remote control w/cable

Model:	RP5000 w/rope	RP5000 w/steel
Boat weight:	app 1500 kg	
Pull:	2268 kg	
Motor:	12V - 3,8HK	
Gearing:	165:1	
Gear:	Planet gear with automatic stop	
Rope:	Ø 6,3 mm 15 meter	
Dim in mm:	397 x 117 x 120	
Weight:	13,2 kg	15,3 kg
Item no	1021083	1021084

Waterproof control box
for RP5000
1021074

1021083



1021084

ROCK® ELECTRIC TRAILER WINCH RES6000 CE

IP66 • Free-running function • Line guide • Incl. relay • Towbar Remote control w/cable

Model:	RES6000 w/rope	RES6000 w/steel
Boat weight:	app. 1850 kg	
Pull:	2720 kg	
Motor:	12V - 4,6 HK	
Gearing:	210:1	
Gear:	Planet gear with automatic stop	
Rope:	Dia 7 mm 24 meter	
Dim in mm:	452 x 161 x 217	
Weight:	25,5 kg	29,5 kg
Item no	1021105	1021085



ROCK® ELECTRIC TRAILER WINCH RES9500 CE

IP67 • Free-running function • Line guide • Incl. relay • Towbar Remote control w/cable

Model:	RES9500 w/rope	RES9500 w/steel
Boat weight:	app. 2900 kg	
Pull:	4313 kg	
Motor:	12V - 4,9HK	
Gearing:	150:1	
Gear:	Planet gear with automatic stop	
Rope:	Dia 9,5 mm 28 meter	
Dim in mm:	540 x 161 x 217	
Weight:	28,6 kg	37,2 kg
Item no	1021106	1021086



ROCK® WIRELESS REMOTE CONTROLS

Wireless remote control for RP3500, RP5000,
RES6000 og RES9500
1021088

Wireless remote control for
RP3500 & RP5000
12V 250 Amp
1021073

Wireless remote control for
RES6000 & RES9500
12V 400 Amp
1021089



1021088



1021073



1021089

PULL SPEED AND CAPACITY

Model	Pull	Speed	Amp.
PR2000	0 kg	4,3 m/min	14
	454 kg	2,7 m/min	60
	680 kg	2,3 m/min	90
	908 kg	1,8 m/min	115
Model	Pull	Speed	Amp.
RP3500	0 kg	7,0 m/min	35
	454 kg	6,0 m/min	87
	908 kg	4,6 m/min	140
	1589 kg	2,3 m/min	200
Model	Pull	Speed	Amp.
RP5000	0 kg	6,3 m/min	34
	908 kg	4,6 m/min	135
	1360 kg	4,0 m/min	155
	1810 kg	3,2 m/min	190
RES6000	2270 kg	2,8 m/min	230
	0 kg	6,0 m/min	80
	680 kg	4,8 m/min	125
	1360 kg	4,1 m/min	160
RES9500	2040 kg	3,2 m/min	205
	2720 kg	2,7 m/min	220
	0 kg	11,6 m/min	70
	1810 kg	3,8 m/min	198
RES9500	2720 kg	3,0 m/min	246
	3630 kg	2,5 m/min	284
	4313 kg	2,1 m/min	330

1852 OIL EXTRACTOR 9 LITRES

Oil suction with hand pump incl. 3 hoses of dia 4, 6 and 10 mm,
all 110 cm long.

Cylinder model 9 litres 1201743

Hose connection

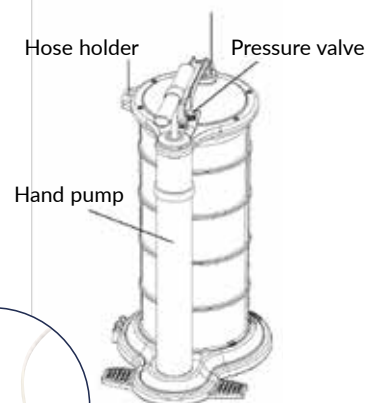
**1852 OIL EXTRACTOR 6 LITRES**

Oil suction round model 6 litres
1201741



1852 MARINE TANK C €

Fuel tank with hose set for Yamaha.
 Very solid petrol tanks produced in heavy duty polyethylene.
 The tanks are supplied with a fuel gauge, 3 meter fuel hose with pump and Yamaha fuel couplings.
 (Fuel hose: 2.05 m before pump and 0.85 m after pump)
 Change any the motor connector to match your motor,
 12 L. 1530006
 24 L. 1530007



1852 FUEL CADDY 53 LITERS C €

Fuel wagon of 53 liters with wheels and siphon pump/gun
 Quality tank in polyethylene, CE approved

- No corroding parts
- Strong - can withstand impact
- Mounted with 3 m hose
- For petrol and diesel

1530148



1852 PLASTIC FUEL CAN INCL. POURING SPOUT

Has a clear strip at the end so you can see how much is left.
 5 L 1530374
 10 L 1530375
 20 L 1530376



SIPHON PUMP - MANUAL

Siphon with manual pump for chemicals, thinners and acids.
 Can be used for petrol, diesel, chemicals, soap, thinner and acids up to 35%.
 Pumps 7 liters per mine.

Total length: 530 mm
 Lgd. on suction hose: 385 mm
 Lgd. on extraction hose: 540 mm
 1531101

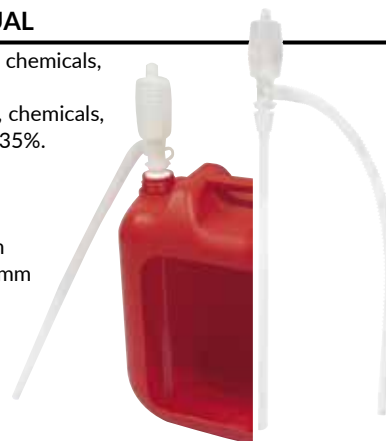

SIPHON PUMP BATTERY POWERED W/AUTOSTOP SENSOR

Battery-powered pump with autostop sensor.
 Can be used for petrol, diesel, kerosene, light oils and water.
 Pumps 9 liters per min and uses 2 D batteries.
 Batteries are purchased separately
 Total length: 592 mm
 Length of suction hose: 385 mm
 Length of extraction hose: 560 mm
 1531103



SIPHON PUMP - BATTERY OPERATED W/AUTOSTOP

Battery-operated pump with autostop.
 Live. with adapters for mounting on different cans.
 Used for petrol, diesel, kerosene, light oils and water.
 Pumps 9 liters per min and uses 4 AA batteries.

Total length: 535 mm
 Length of suction hose: 460 mm
 Length of extraction hose: 715 mm
 1531104



1852 FOR BOATS **BOAT COVER**

1852 high quality boat cover. Made from 300 denier gray polyester which is water resistant and comes with trailer straps. The Cover protects against rain, dirt and dust. Available in 8 models, of which the 2 smallest are for inflatable boats and smaller dinghies. In addition, there are 3 models for Center Console boats.

- 300 Denier Polyester
- Reinforced bow, stern & eyes
- Trailer straps Included
- Storage bag included



8 models:

Model	Size	Fot	Max width	Item no
Mini	240-300 cm	8-10"	155 cm	1041828
Junior	300-360 cm	10-12"	175 cm	1041829
XS	360-420 cm	12-14"	173 cm	1041831
S	427-488 cm	14-16"	173 cm	1041832
M	427-488 cm	14-16"	229 cm	1041833
L	488-564 cm	16-18,5"	239 cm	1041834
XL	518-579 cm	17-19"	244 cm	1041835
XXL	610-670 cm	20-22"	254 cm	1041836

1852 FOR BOATS **OUTBOARD COVER**

1852 outboard Cover is made of strong blue 600D polyester material for maximum protection, supplied in a storage bag.

Model	Item no
2,5-10HP	1041853
15-25HP	1041854
25-40HP	1041855
50-115HP	1041856
115-250HP	1041857



1852 FOR BOATS **BOAT SUPPORTS FOR MOTOR AND SAILBOATS**

Adjustable boat supports in solid steel with black powder coating, which makes them more durable and ensures a longer life. Rubber protection on the hull plate protects against scratches, while also providing good support for the boat. Two supports are calculated per 8-10 feet. The boat must rest on the keel.

Boat support for motor boats
Max load 2500 kg

Hight	Item no
50-80 cm	1531161
60-90 cm	1531162
75-105 cm	1531163
90-120 cm	1531164



Boat support for sailboats
Max load 1250 kg

Hight	Item no
80-120 cm	1531171
110-155 cm	1531172
130-175 cm	1531173
150-195 cm	1531174
170-215 cm	1531175
190-235 cm	1531180



Boat support/booth for motor and sailing boats
Max load 3000 kg

Hight	Item no
35-55 cm	1531169



Accessories for boat supports

	Item no
Curved top plate	1531165
Flat top plate	1531166
Rubber sheet 20x20 cm for top plate	1531167



NEW



1852 PROFLEX BOAT-SHAPED AND RECTANGULAR COVERS

A cover protects against wind and weather. But it must be able to do much more. It must also be able to be used again and again. And then it must be easy to work with. 1852 boat shaped tarps provide a better fit and less excess tarp. The cover is sewn to form at one end, so that any excess material against the bow is minimized.

- 240 g./m2 reinforced plastic in top quality - the best protection for the boat in all kinds of weather!
- Long service life - withstands frost and sun without cracking. From -40° to 80°C.
- High UV protection - protects against sunlight.
- Environmentally friendly and economical - made from environmentally friendly HDLD polyethylene (high density polyethylene), which can be reused and does not pollute when burned.
- There are pre-punched holes (Dia 15 mm) every 10 cm, the holes are welded for good durability.

Cloth type: 100% polyethylene HDPE leno material, LDPE coating (high density polyethylene tablecloth with low density polyethylene coating)

Fabric weight: 220 g/m2

Cover weight: 230-250 g/m2

Tensile strength: 580 N/5 cm in the longitudinal direction = 59 kg.
440 N/5 cm in the width direction = 45 kg.

Temp. resistant: -40/+80°C

UV resistant: 200 Kly

Size: Finished size, +/- 2%

Finishing: Eye tape in the longitudinal direction.

Eyelet: 250 g/m2 with Ø 15 mm eyelets every 10 cm

Eye tensile strength: 580 N = 59 kg.



RECTANGULAR COVER

Size	Item no
3 x 4 meter	1041702
4 x 6 meter	1041708
5 x 7 meter	1041710
6 x 10 meter	1041712
8 x 12 meter	1041711

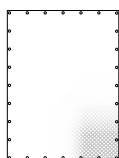

SHAPED COVER

Size	Item no
5 x 7 meter	1041693
5 x 10 meter	1041694
6 x 10 meter	1041697
6 x 12 meter	1041699
7 x 12 meter	10416991
8 x 14 meter	1041701

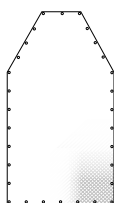

THE ADVANTAGES OF THE 1852 COVER:

- Flexible attachment - pre-punched holes/eyes every 10 cm
- No metal eyes = no scratches in gelcoat
- High tensile strength

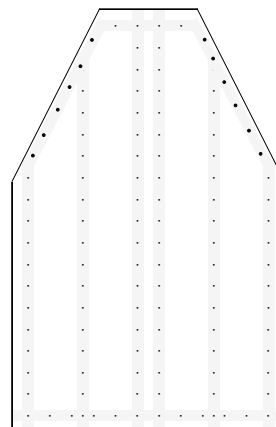

Punched-out eyelets on large parts of the cover make fastening much easier

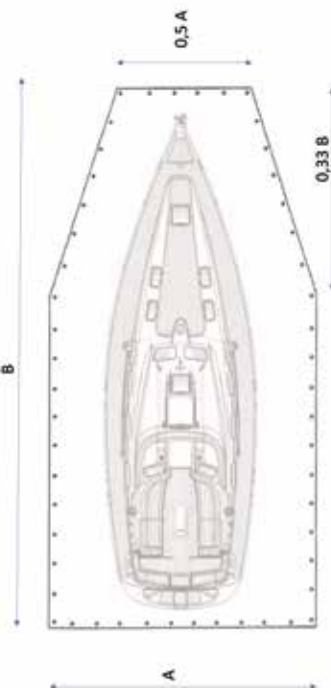

The boat-shaped covers are tapered after 2/3 of the total length. The narrow short side is half as long as the width of the cover.

Thor EXHAUST SILENCER

Thor exhaust silencer are among the best on the market. The system can be used on both sailing and motor boats. The muffler/water trap on the Thor model is constructed with 2 stainless steel ends fitted with a rubber bellows.

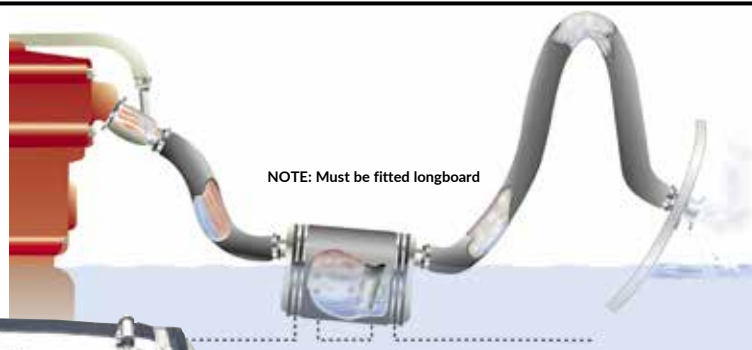
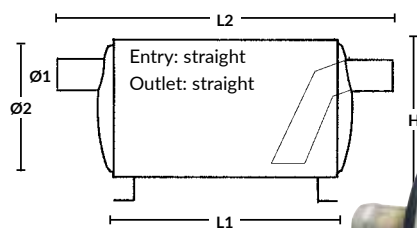

1852 EXHAUST PIPES

Beautiful fully cast stainless steel, AISI 316, through for exhaust. High gloss polished w/plastic counter flap.

MAX HP	Ø1	Ø2	L1	L2	H	Liters	Item no
35	45 mm	127 mm	250 mm	400 mm	145 mm	3.0	152P1001
35	51 mm	127 mm	250 mm	400 mm	145 mm	3.0	152P1002
50	40 mm	160 mm	250 mm	420 mm	190 mm	5.0	152P1013
50	45 mm	160 mm	250 mm	420 mm	190 mm	5.0	152P1011
50	51 mm	160 mm	250 mm	420 mm	190 mm	5.0	152P1012
100	51 mm	160 mm	375 mm	560 mm	190 mm	7.5	152P1015
100	60 mm	160 mm	375 mm	560 mm	190 mm	7.5	152P1017
100	63 mm	160 mm	375 mm	560 mm	190 mm	7.5	152P1018
100	76 mm	160 mm	375 mm	560 mm	190 mm	7.5	152P1020
150	76 mm	203 mm	375 mm	760 mm	215 mm	12.5	152P1031
200	89 mm	203 mm	375 mm	760 mm	215 mm	12.5	152P1035
200	89 mm	203 mm	500 mm	760 mm	215 mm	15.0	152P1036
200	101 mm	203 mm	500 mm	760 mm	215 mm	15.0	152P1037
300	101 mm	245 mm	500 mm	775 mm	260 mm	25.0	152P1041
300	124 mm	245 mm	500 mm	775 mm	260 mm	25.0	152P1042

A-Hose dia	B-Lgt.	C-Total lgt	Item no
40 mm	75 mm	99,5 mm	1514881
45 mm	75 mm	100,0 mm	1514882
51 mm	75 mm	101,0 mm	1514884
60 mm	75 mm	102,5 mm	1514885
76 mm	90 mm	122,4 mm	1514888
90 mm	110 mm	144,5 mm	1514890
100 mm	115 mm	150,0 mm	1514892
125 mm	140 mm	184,0 mm	1514893
150 mm	150 mm	196,0 mm	1514894

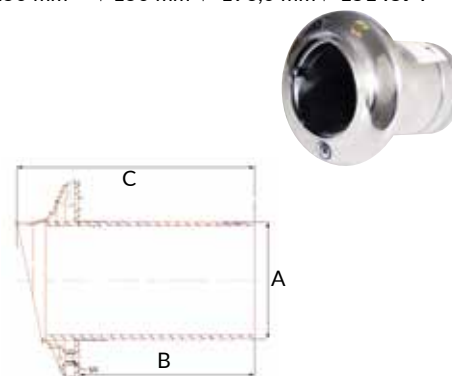

Thor EXHAUST PIPES

Item no	Ø1	Ø2	L
152P1150	38 mm	78 mm	130 mm
152P1151	45 mm	85 mm	130 mm
152P1152	51 mm	91 mm	130 mm
152P1154	60 mm	100 mm	130 mm
152P1155	63 mm	103 mm	130 mm
152P1156	76 mm	126 mm	130 mm
152P1157	89 mm	139 mm	130 mm
152P1158	101 mm	151 mm	130 mm

Item no	Ø1 mm	Ø2 mm	L mm
152P1160	38 mm	88 mm	125 mm
152P1161	45 mm	95 mm	125 mm
152P1162	51 mm	101 mm	125 mm
152P1163	57 mm	107 mm	125 mm
152P1164	60 mm	110 mm	125 mm
152P1165	63 mm	113 mm	125 mm
152P1166	76 mm	126 mm	140 mm
152P1167	89 mm	139 mm	170 mm
152P1168	101 mm	151 mm	190 mm

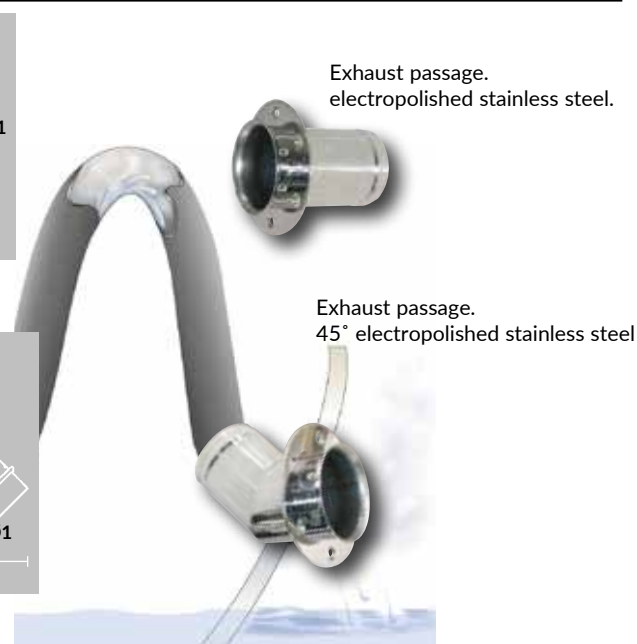
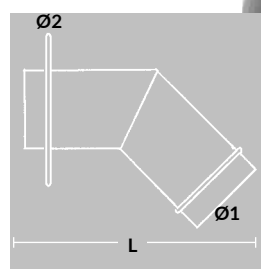
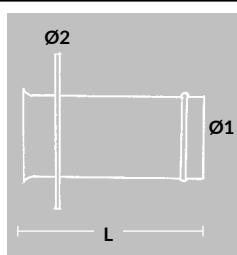

Thor EXHAUST ELBOWS

Volvo MD 5 - The coolant spigot points forward
152P12201

Total lgt 300 mm



Volvo MD 1-3, 6, 7, 11, 17
The coolant spigot points to the rear
152P1221

Total lgt 235 mm
1 1/4" thread

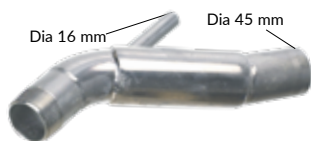

Volvo MD 1-3, 6, 7, 11, 17 -
The coolant spigot points forward
152P12211

Total lgt 235 mm
1 1/4" thread

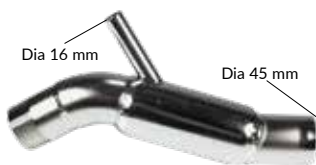

Volvo MD 1-3, 6, 7, 11, 17
W/flange. The coolant spigot points to the rear
152P12215

Total lgt 300 mm

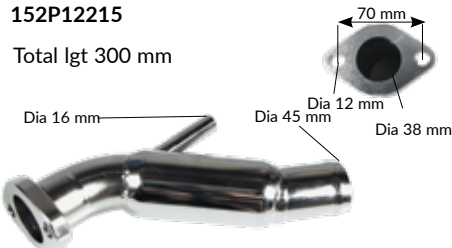

Volvo MD 1-3, 6, 7, 11, 17 - Special
W/flange. The coolant spigot points forward
152P12216

Total lgt 300 mm

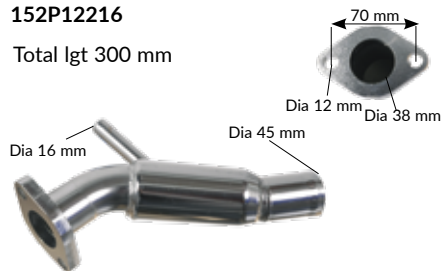

Volvo MD 22
152P1222

Total lgt 160 mm

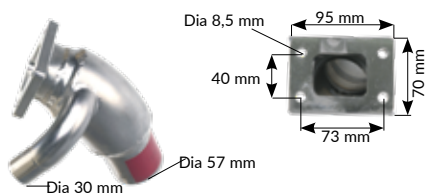

Volvo 2010, 2020, 2030, 2040
152P1223

Total lgt 180 mm



Volvo MD 21
152P1230

Total lgt 260 mm
3/4" thread



BUKH DV 10-20-24
152P1231

Flange 152P1235

Total lgt 180 mm
1 1/2" thread



Yanmar QM serie
152P1224

Total lgt 245 mm
1 1/2" thread



Yanmar 6 LY serie
152P1225

Total lgt 195 mm



Yanmar 33H2-TE
152P1227

Total lgt 210 mm
Outlet 63 mm



BUKH DV36
152P1233

Total lgt 285 mm



Yanmar 4JHE 152P1236

Total lgt 165 mm



INFO WAKEWATER

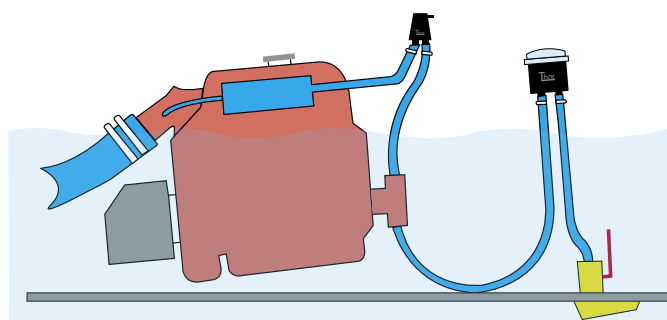

SIMPLE CIRCUIT COOLING

Cool facts about how to avoid an anti-siphon that leaks in the engine room or how to prevent clogging in the cooling system.

The cooling water intake is the first connection that can release particles from the cooling water. It is therefore important that a strainer is fitted on the outside which does not allow larger particles to pass through the hose. For safety reasons, the feed-through should be fitted with a tap that can shut off the water in the event of an accident, repair etc.

Note that the cooling water strainer has an inlet and an outlet that must be connected correctly. The strainer must be checked for dirt and be cleaned where it is mounted, and must fit tightly in the lid. It is important that the strainer is placed approx. 0.5 meters above the waterline and that the hoses are of a good quality that do not "collapse" in a hot engine room and prevent water from passing through.

The strainer's outlet is connected to the pump's inlet connection, and via the pump's outlet connection to the anti-lift siphon, which must be located at roughly the same height as the strainer.

The anti-lift siphon has no specific flow direction. It breaks the water flow and thus the siphon effect when the engine is stopped. The outlet of the siphon is connected to the motor and the circuit is closed. The anti siphon is connected to the spigot on the silencer. If there is no spigot on the muffler, you can mount a connecting pipe on the exhaust hose after the engine exhaust silencer as close to the muffler as possible.

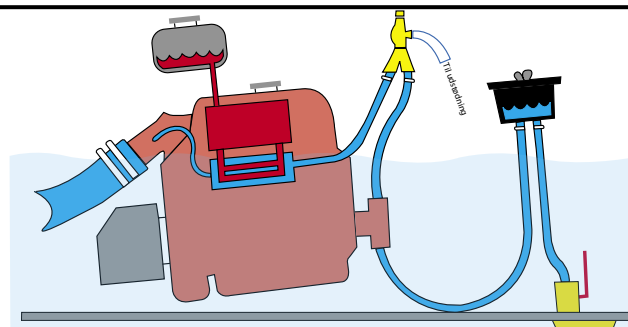

DOUBLE CIRCUIT COOLING

Thor ANTI-LIFT SIPHON

Powerful anti-siphon.

Fits 16-19-25-32 mm hoses.

Can be connected to exhaust if one want a closed installation.

Dimensions: H: 163 - W: 85 - D: 37 mm

Stud Ø 8 mm

16-19-25-32 mm **1560692**



Thor QUICK-FIT SEA STRAINER

Luxury strainer for the discerning sailor. The strainer is mounted on the practical QUICK-FIT hanger, which makes it easy to mount and quick to clean. Extra strong walls provide great stability, and the large strainer provides extra flow.

Thor filter 12-16-19 mm **1560470**

Thor filter 19-25-32 mm **1560480**

	1560470	1560480
Sl. dia	12-16-19	19-25-32
Dia.	123	168
B	130	175
C	115	145
Hight	205	245

**BEST
CHOICE**

SPARE PARTS FOR STRAINER

Lit for 1560470	1560472
Sieve for 1560470	1560473
O-ring for 1560470	1560474
Holder for 1560470	1560475
Lit for 1560480	1560482
Sieve for 1560480	1560483
O-ring for 1560480	1560484
Holder for 1560480	1560485

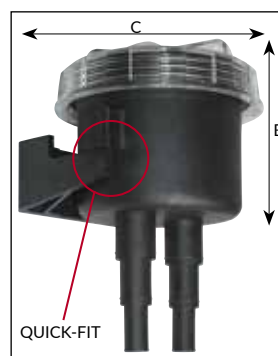

Examples shown are for engine cooling:
Seawater intakes are always installed with the strainer against the direction of sailing for engine cooling and with the direction of sailing for toilet water intakes

1852 HOSE CLAMP AISI 316 STAINLESS STEEL

British type 316 stainless steel turnbuckle with a galvanized 316 stainless steel screw for maximum strength.

The smooth inner profile of the tension band and the round edge provide protection for all hose types

Dia.	Width	Max moment	No	Item no
11-16 mm	9,7 mm	3Nm	10 pcs.	1540320
11-16 mm	9,7 mm	3Nm	2 pcs.	1540321
13-20 mm	9,7 mm	3Nm	10 pcs.	1540322
13-20 mm	9,7 mm	3Nm	2 pcs.	1540323
18-25 mm	11,7 mm	4,8Nm	10 pcs.	1540324
18-25 mm	11,7 mm	4,8Nm	2 pcs.	1540325
25-35 mm	11,7 mm	4,8Nm	10 pcs.	1540326
25-35 mm	11,7 mm	4,8Nm	2 pcs.	1540327
32-45 mm	11,7 mm	5,2Nm	10 pcs.	1540328
32-45 mm	11,7 mm	5,2Nm	2 pcs.	1540329
40-55 mm	11,7 mm	5,2Nm	10 pcs.	1540330
40-55 mm	11,7 mm	5,2Nm	2 pcs.	1540331
55-70 mm	11,7 mm	5,2Nm	10 pcs.	1540332
55-70 mm	11,7 mm	5,2Nm	2 pcs.	1540333
70-90 mm	11,7 mm	5,2Nm	10 pcs.	1540334
70-90 mm	11,7 mm	5,2Nm	2 pcs.	1540335
90-120 mm	11,7 mm	5,2Nm	10 pcs.	1540336
90-120 mm	11,7 mm	5,2Nm	2 pcs.	1540337
150-180 mm	11,7 mm	5,2Nm	1 pcs.	1540340
180-210 mm	11,7 mm	5,2Nm	1 pcs.	1540342



HEAVY HOSE CLAMPS A2 AISI 304

Heavy buckle strap. Stainless steel AISI 304. With umbraco screw

Dia.	Item no
17-19mm	1544012
20-22mm	1544014
23-25mm	1544015
26-28mm	1544016
29-31mm	1544017
32-35mm	1544018
35-40mm	1544020
40-45mm	1544040

Dia.	Item no
45-50mm	1544060
50-55mm	1544070
55-60mm	1544080
60-65mm	1544090
65-70mm	1544100
70-75mm	1544110
75-80mm	1544120
80-85mm	1544130

Dia.	Item no
85-90mm	1544140
90-95mm	1544150
95-100mm	1544160
100-105mm	1544170
105-110mm	1544180
110-115mm	1544190
115-120mm	1544200
123-130mm	1544460

Dia.	Item no
131-140mm	1544480
141-150mm	1544490
151-160mm	1544492



STRAHL GLASS

Strahl glass is produced in polycarbonate - an unbreakable material with the same elegance and clarity as glass. The glasses appear in an elegant design and without machine joints - which gives an incredibly nice finish. Strahl glass is a safe and durable alternative to regular glass and can be washed in the dishwasher.

Jug 1567 ml. 1 piece	1851769
Wine glass 384 ml. 4 pieces.	1851771
Glass Rocks 296 ml. 6 pieces.	1851772
Glass Vivaldi 414 ml. 6 pieces.	1851773
Stemless wine glass 384 ml. 4 pieces.	1851774
Glass Highball 296 ml. 4 pieces.	1851775
Glass Highball 414 ml. 4 pieces.	1851776
Shot glass 35 ml. 12 pcs.	1851777
Beer mug 443 ml. 4 pieces.	1851778



1851771



1851772



1851773



1851774



1851777



1851775



1851776



1851778



1851769

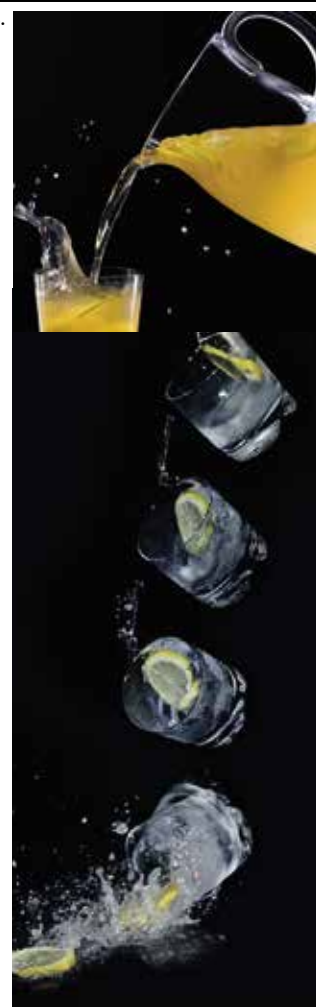

1851767



1851768



1851766



1851764



1851765

**GLASSES IN A NICE GIFT BOX**

Champagne glass 166 ml. 4 pieces.	1851764
Wine glass 245 ml. 4 pieces.	1851765
Stemless wine glass 247 ml. 4 pieces.	1851766
Beer glass 285 ml. 4 pieces.	1851767
Glass of Rocks 355 ml. 6 pieces	1851768

1852 KETTLE

Kettle that can be used for both gas and induction. Whistles when the water boils

1.2 liters • Ø 165 mm. Height 125 mm
1851795

2.3 liters • Ø 183 mm. Height 130 mm
1851798



TEAK TABLETOPS

Thai teak wood and genuine craftsmanship are an unrivaled combination. For centuries, teak wood has proven to be unsurpassed for outdoor use. The natural oils preserve the wood against weather and wind for years. Teak wood is also resistant to insects and fungi. Each part is machined and sanded before assembly. The furniture is put together by hand and fit and craftsmanship are carefully coordinated. Finally, the surface is polished to a silky matte finish.

The teak table tops have plywood cores. 22 mm thick, of which 5 mm teak.

FSC-approved teak wood

The joint is made with SIKA-flex.



Teak tabletops square

Size	Item no
35 x 60 cm	1122150
50 x 75 cm	1122151

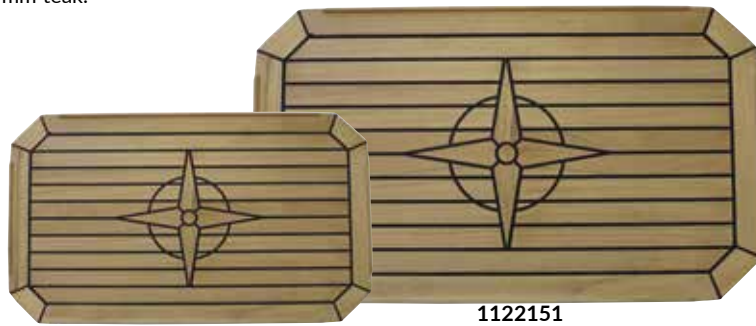

Teak table top with round corners

60 x 95 cm	1122152
------------	---------



Foldable teak table tops

Comes with strong supports that can be pushed out from under the plate, to hold the sides when they are unfolded

Size	Item no
60 x 70/35 cm	1122153
100 x 70/35 cm	1122154

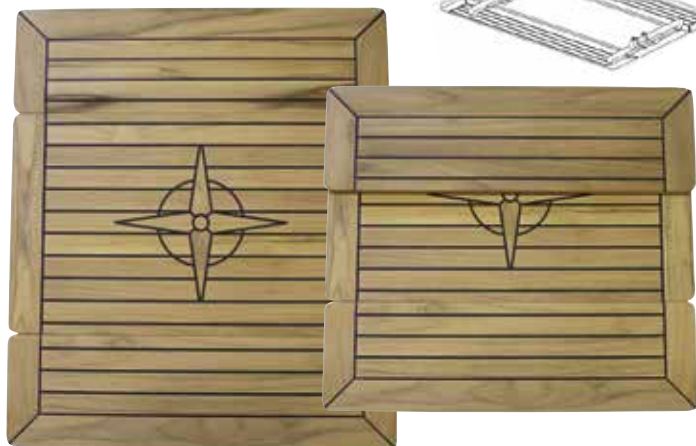

1122153



1122154

WELCOME ON BOARD MATS

- Navy blue with white text
- Strong edging tape
- Anti-slip coating on the backside

Square w/ "Welcome aboard" motive, 61x45 cm	1121650
Semi-round w/woven compass motive, 91x47 cm	1121661
Long mat 45x150 cm	1121662
Square w/woven anchor motive, 61x45 cm	1121670
Square w/woven anchor motive, 45x30 cm	1121669



1852 FOLDING SEAT WITH ARMRESTS AND 6 SETTINGS

Can be used as a comfortable seat with backrest or fold it out and use it as a cushion/mattress

- 6 different settings
- Armrests for good comfort, the armrests can also be folded into the seat for a larger sitting surface
- Bottle holder on armrest
- Lightweight steel construction
- 300 D polyester
- 7 cm foam in the back and seat
- Waterproof, reinforced material on the bottom
- Adjustable backpack straps for easy carrying
- Width: 52 cm • Length: 82 cm

Navy 1121430

Adjustable back-packs so it can be carried easily



Armrests folded down into the seat for a larger sitting surface



Click the seat in 6 different positions

1852 FOLDING SEAT WITH 6 SETTINGS



Can be used as a comfortable seat with backrest or fold it out and use it as a cushion/mattress

- 6 different settings
- Lightweight steel construction
- 300 D polyester
- 7 cm foam in the back and seat
- Waterproof, reinforced material on the bottom
- Carrying handle

Width: 40 cm • Length: 75 cm
Navy 1121425

Width: 48 cm • Length: 93 cm
Navy 1121427

Click the seat in 6 different positions



Waterproof, reinforced material on the bottom



MENSA HEATING NATE'S PILLOW WITH HEAT

The cushion that keeps you warm when you are in good company on your boat in the harbor - or during a longer sailing trip on the open sea.

You can take NATES with you everywhere and keep warm in all kinds of weather.

NATES has three heat levels, as you know them from the seat heater in your car.

The cushion keeps heat from 3-6 hours, depending on which setting/level of heat you use.

Comes with water-resistant fabric, waterproof zipper and a 10,000 mAh power bank inside the cushion.

Size 40 x 40 x 5 cm

1121435

• ON/OFF

Press for 2 sec. for ON or OFF.

A single press changes the heat level:

Red = high (9.5W)

Orange = medium (7W)

Green = low (5W)

• Heating element

Surface temperature:

Max. 40°C at highest level

Warm-up: <1 min.

• Handle / shoulder strap

Handle can be unbuttoned so it becomes a shoulder strap



Extra powerbank
10.000mAh for
1121435
1121436



1852 ALL
DURING
THE
YEAR **STORM MULTI-TOOL 16 IN 1**

1852 Storm Multi tool of 3CR13 stainless steel. A very strong and powerful multi-knife and a knife blade that is particularly useful for cutting rope with and also a special rope cutter blade (no. 8). The multiknife comes with a belt pouch. Size: 104 x 42 x 19 mm (closed state) Total length 152 mm, weight 305 g. **1354065**



- 1 Spidstang
- 2 Tang
- 3 Skævbidder
- 4 Linial
- 5 Saks
- 6 Phillips skruetrækker
- 7 Krogudtager
- 8 Tovskærer
- 9 Dåseåbner
- 10 Sav
- 11 Flad skruetrækker
- 12 Metalfil
- 13 Kniv
- 14 Proptrækker
- 15 Oplukker
- 16 Glasknuser

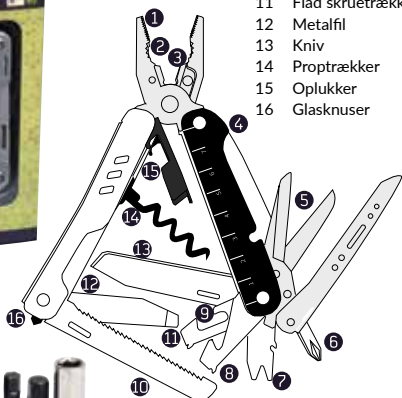

Incl. bit set, the bit holder is mounted on the screwdriver

1852 ALL
DURING
THE
YEAR **FLAGPOLE TEAK**

FSC approved teak flag game with fitted teak cleat and stainless bushing. Dia 25 mm

- Bushing Dia 25 x 45 mm**
- 60 cm teak 1123200
 - 75 cm teak 1123210
 - 90 cm teak 1123220
 - 120 cm teak 1123230
 - 150 cm teak 1123240

- Bushing Dia 25 x 100 mm**
- 150 cm teak 1123247



1852 ALL
DURING
THE
YEAR **SHORT RUBBER BOOT**

The 1852 rubber boot is a really good boot designed for sailing. The boot is made of soft rubber with a good inner sole with the well-known non-slip sole (razor cut sole), which does not make marks on the tire.

The 1852 rubber boot is 100% waterproof and has reinforcements on the heel, instep and toe.

- 100% rubber
- The well-known non-slip razor cut sole
- Removable, padded insole
- Reinforced heel, toe and instep
- Quick-drying polyester lining
- Really good fit
- Colour: Gray with light grey/red reinforcements
- Size 37-47

1303920-(str.)



1852 ALL
DURING
THE
YEAR **NEOPRENE SHOES & BOOTS**

Neoprene shoes size 33-47

Neoprene boots size 36-47

Shoes 1352512-(str.)

Boots 1352513-(str.)



1852 ALL
DURING
THE
YEAR **SAILING GLOVES WITH SILICONE GRIP**

Fantastic sailing gloves without fingers with extremely good and durable silicone grip.

- Perfect fit
- Velcro closure
- Extremely durable silicone grip

- | Size | Item no |
|------|-------------|
| XS | 1352120-XS |
| S | 1352120-S |
| M | 1352120-M |
| L | 1352120-L |
| XL | 1352120-XL |
| XXL | 1352120-XXL |



1852 WATERPROOF BAGS

Waterproof bag with shoulder strap.
Extra room in the front with a waterproof zip.

10 ltr 1354233
15 ltr 1354234
25 ltr 1354235



1852 WATERPROOF BAG

Waterproof bag in PVC. Small and handy, perfect for short boat trips, camping, leisure and training. A waterproof pocket on the inside for keys, wallet and mobile phone. Small outer pocket with zipper.

Supplied with strong handles and carrying strap, which can be clipped on.

20 L
46 x 25 cm
1354250



1852 WATERPROOF BACKPACK

Waterproof backpack.
Perfect for boat trips, kayak trips etc.
Keeps clothes and other accessories dry.
24 ltr 1354239



1852 WATERPROOF BACKPACK 30 LITERS

Solid, waterproof backpack in PVC.
Perfect for boat trips, paddling trips, walks etc.
Good padding against the back.
30 ltr
1354240



1852 FLOATING SUIT FOR CHILDREN & ADULTS €

50N buoyancy. Comfortable and functional floating suit.

- Supplied in tote bag.
- The suit meets the requirements for buoyancy according to EN ISO 12402-6
- We always recommend a life jacket together with a floating suit.
And especially children must always wear a life jacket.
- Red/black or Yellow/black with reflectors

Size	Red/black
120	1185122-120
140	1185122-140
160	1185122-160

Size	Weight	Chest	Gul/sort
XS			1185123-XS
S	→80 kg	84-92 cm	1185123-S
M	80-85 kg	92-100 cm	1185123-M
L	85-90 kg	100-108 cm	1185123-L
XL	90-110 kg	108-116 cm	1185123-XL
XXL	110-120 kg	124-132 cm	1185123-XXL



Child



1852 MARE DUNA LITY **ISO SWIM - WATER SKI WEST 50N C€**

A good vest for fun on the water.

- Soft foam
- Reflex on shoulder
- 4 belts with click buckle
- EN ISO 12402-5

Kg	Chest	Black/lime
30 - 50 kg	71-91 cm	1188954
50 - 70 kg	91-111 cm	1188955
70+ kg	111-127 cm	1188956



1852 MARE DUNA LITY **ISO ACTIVE SWIM VEST 50N C€**

Comfortable swimming vest with good fit. Solid color with zipper, drawstring and laces.

	Red/black	Navy/grey
30 - 50 kg	1188940	1188945
50 - 70 kg	1188941	1188946
70 - 90 kg	1188942	1188947
90+ kg	1188943	1188948



1852 MARE DUNA LITY **LIFE JACKET 100N C€**

Comfortable lifejacket with split buoyancy in front, back and collar. Comes with reflectors, crotch strap, whistle and zipper. Colour: Orange

3 - 10 kg	1188609
10 - 20 kg	1188610
20 - 30 kg	1188620
30 - 40 kg	1188630
40 - 60 kg	1188641
60 - 70 kg	1188650
70 - 90 kg	1188660
+ 90 kg	1188670



1852 MARE DUNA LITY **165N AUTOMATIC VEST C€**

A fully automatic inflatable lifejacket that has a compact and slim design.

- Available with or without harness
- 165 N buoyancy with 33 gram CO² cartridge
- 600 denier fabric material
- Velcro closure for easy repacking
- Halkey-Roberts trigger mechanism
- Zip pocket
- ISO 12402-3 approved
- Approved under class 150N

Vest 165N
Navy 1186032
Red 1186033

Co² cartridge 33g incl. tablet
Halkey-Roberts 1186050



1852 MARE DUNA LITY **ISO DINGHY/KAYAK VEST 50N C€**

A vest with really good freedom of movement in the arms. Maneuvering on the water is no problem with this vest.

- Soft foam
- Suitable for dinghy and kayak sailing
- Flexible shoulder strap
- Full zip
- Zip and Velcro pocket
- EN ISO 12402-5

Kg	Chest	Red/black
30 - 50 kg	71-91 cm	1188920
50 - 70 kg	91-111 cm	1188921
70+ kg	111-127 cm	1188922
70+ kg XXL	127-137 cm	1188923



1852 TRIANGULAR TUBE

- 1 person triangle tube with nylon cover
 - Tube Ø 137 cm
 - Boston valves
 - 4 handles
 - 18 meter line
 - With hand pump
- 1191940



DRAG LINES FOR TUBES

- 1852 line for 1 person tube **1191375**
- 1852 line for 2 pers. tube, 18 metres **1191376**



1852 LINES FOR WATER SKIS

- With grip - 23 m **1191300**
- With rubber coated wooden handle - 23 m **1191301**
- With aluminum handle 2 sections - 23 m **1191305**
- With aluminum handle covered with EVA foam 4 sections - 19 m **1191306**



1852 WAKEBOARD LINE

- 1852 line w/rubber handle, 20 meters **1191313**



1852 TRIANGULAR TUBE PACKAGE

- 1 person triangle tube with nylon cover
 - Tube Ø 137 cm
 - Boston valves
 - 4 handles
 - 18 meter line
 - Foot pump
- 1191961

Package
Tube
Foot pump
Pull line



1852 CRAZY BANANA

- 1-3 people
 - 260 cm
 - 3 pieces. oversize handle w/padded grip
 - Nylon cover
 - Quick release
- 1191994



1852 | FOR BOAT CITY **DECK II TUBE**

- 2-person inner tube
 - Strong nylon cover with strong PVC inner tube
 - 4 handles.
- Dia 152 cm
1191942

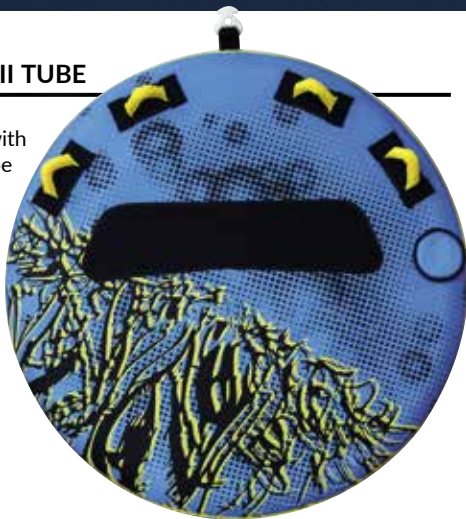

SOFA TUBES

Lots of handles for a safe ride, whether you're sitting on your butt or your knees.
Made of strong 840D nylon, knuckle protection under the handles and reinforcement on the seat surfaces.

2 people 175x168 cm
1191975

3 people 200x198 cm
1191976



DOUBLE DELTA TUBE

Sit in it, lie on your stomach or straddle the middle.
Tube for two people, making it twice as fun.
Strong nylon cover and double rings made of PVC.
Four foam handles.
Width: 152 cm
1191998



1852 | FOR BOAT CITY **FUEL TUBE FOR 1 PERSON**

- Tube for 1 person.
 - PVC inner tube
 - 420 denier cover
 - 4 soft handles
- Dia 137 cm 1191962



WATERSKI COMBO VEGA ADULT & JUNIOR

Classic combi skis that suit both the family, the all-round water skier but also the discerning water skier.
They are easy to get on, and have a narrow enough profile to be easy to maneuver in the turns.
Concave underside (curves downwards) for best grip on the water surface.
Adjustable bindings from size 37 to 46.

Red/orange 170 cm 1191006
Blue/yellow 145 cm junior 1191010



1852 INFLATABLE SUP BOARDS JUNIOR & ADULT

Fantastic boards that can be used by both beginners and the experienced.

As the name suggests, the 2 Allround boards can be used for everything, but if you want to be challenged a bit, then you should try the Touring board, on which you can progress a little faster.

The touring board is a double layer board, which makes it stiffer and more stable.

- Versatile SUP boards - easy to maneuver with 1 removable center fin and 2 side fins
- Ultra stable
- Strong and durable
- For users of all levels - beginners as well as experienced
- Fully inflated in 5-10 min. (15 PSI max).
- Portable - easily rolled up and placed in the included backpack.
- Contains: SUP, bag, an adjustable aluminum paddle 165-215 cm, rep. set and a hand pump with manometer.

Model	Str.	Volume	Max carrying	Weight	Item no
300 alround	297 x 76 x 13 cm	210 L	110 kg	8 kg	1194136
320 alround	320 x 76 x 15 cm	304 L	140 kg	8,5 kg	1194137
365 tour	365 x 76 x 15 cm	320 L	150 kg	12,3 kg	1194138



ELECTRIC PUMP

Powerful pump that quickly inflates your SUP board.

12V pump for cigar plug.

Set to desired pressure, stops automatically.

- Pressure: 0-16 PSI
- LCD display
- Power cord: 3 m
- Hose: 1.1 m
- 6 adapters for different valves

Pump with 12V plug, 70 litres/min. **1193266**



RECHARGEABLE ELECTRIC PUMP

The pump can be used to inflate e.g. your SUP board or deflate it.

The pump can both use the built-in lithium battery or 12V cigarette socket.

A charge takes approx. 7 hours

- Material: ABS
- Voltage: DC 12V
- Pressure: 0-16 PSI
- Accessories: air hose 1 m / USB cable for charging 5V/2Amp
- Power: 100W
- Battery capacity: Lithium battery, 4000mAh
- Airflow: 350(A)L/min 70(B)L/min can inflate and deflate
- 2 stage inflation: A stage: low pressure, fast inflation 350L/M
B stage: High pressure, slow inflation 70L/M

• Size: 25.2 x 17.5 x 13.3 cm

• Weight: 9 kg

• LCD display

• 6 adapters for different valves

Pump with lithium battery, 70 to 350 litres/min. **1193268**



1852 MARINE OUTDOOR LIFE **ROPE**

Mooring line PP black	Item no
Dia 10 mm 2 pcs. - 6 meters	S778.07507006
Dia 12 mm 2 pcs. - 6 meters	S778.07507206
Dia 14 mm 2 pcs. - 6 meters	S778.07507406
16 Braided PP rope white w/blue brand thread	
Dia 10 mm 15 meters	S778.07823015
16 Braided PP rope black	
Dia 12 mm 10 meters	S778.07823210
3-Stripped PP rope black	
Dia 10 mm - 30 meters	S778.07911030
Dia 12 mm - 30 meters	S778.07911230
Dia 14 mm - 30 meters	S778.07911430
3-Stripped PP rope white - 30 meters	
Dia 10 mm - 30 meters	S778.07921030
Dia 12 mm - 30 meters	S778.07921230
Dia 14 mm - 30 meters	S778.07921430
3-Stranded Polyester/PP rope white w/nylon covs	
Dia 12 mm - 35 meters	S778.07948235



1852 MARINE OUTDOOR LIFE **ROPE GAUGE**

Rope gauge - used for rope from 6 to 20 mm
It measures from 0.1 meter and up
1397205



1852 MARINE OUTDOOR LIFE **ROPE BURNER/CUTTER WITH BATTERY**

1852 rope burner with rechargeable lithium battery 18V 2 Ah 90W
Supplied in a strong plastic box with charger and cleaning brush.
1397206

Extra battery for 1852 rope burner
18V 2 Ah
1397208

Charger 21V, 5 Ah for 1852 rope burner
1397209



1852 MARINE OUTDOOR LIFE **TURNBUCKLE PROTECTOR**

Model	For cap screws	Navy	Grey
37 cm	8 & 10 mm	1153583	1153582
55 cm	11 & 13 mm	1153584	1153587



EXPORT ORDERS

Contact Jesper Cramer
jk@palby.dk • +45 40 18 58 10

Place an order at
orders@palby.dk

All export orders are sent from Denmark



AutoStore



FLAK

Palby Marine

NAUTEC



 Palby Marine

Korsvej 3
6000 Kolding
Denmark

Office 500 m²

Warehouse and Autostore 7.000 m² (Location: Denmark)

 NAUTEC

Dockplatsen 12
211 19 Malmö
Sweden

Office 400 m²

 FLAK

Skibåsen 37
4636 Kristiansand
Norway

Office and warehouse
6.000 m²